

HULTDINS MultiGrip

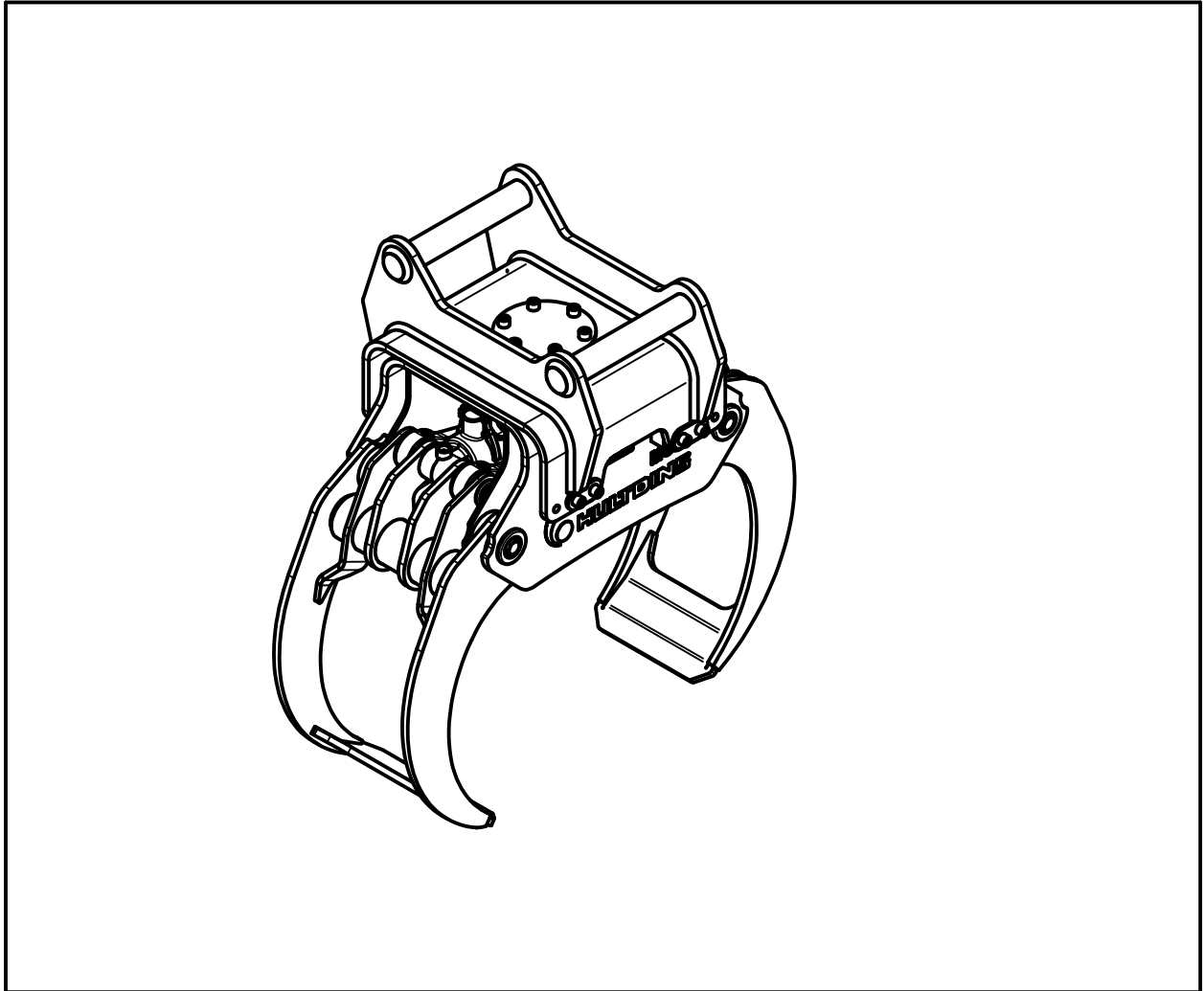

2011-01-28

Rev. 00

Doc.Nr. 7734603-EN

Utg. 01-12

English

MultiGrip 12 / S60

Spare Parts manual

0734603

S/N 059-0001 & up

MultiGrip 12

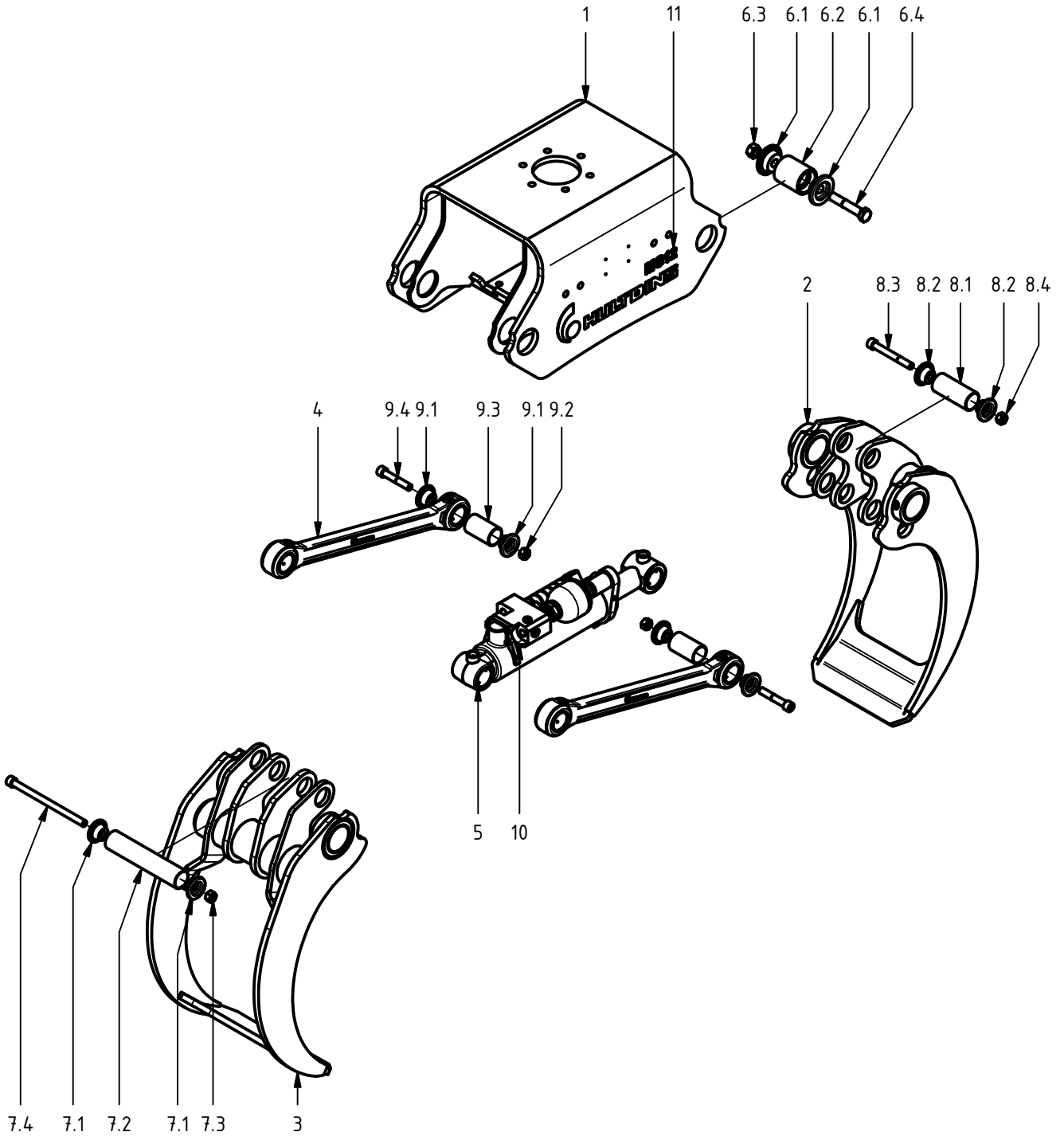

Item	Qty.	Part Number	Description	Notes
1	1	0734043	Frame MG 12	
2	1	0734088	Grapple arm, male	
3	1	0734089	Grapple arm, female	
4	2	0660910	Push rod asm.	
5	1	0150001	Hydraulic cylinder \varnothing 80/56	
6	4	0680544	Pin joint \varnothing 70 asm.	
6.1	2	0680021	Washer \varnothing 70	
6.2	1	0680009	Pin	\varnothing 70 x 82
6.3	1	0106032	Hex nut	ISO 4032 M20
6.4	1	0104617	Hex hd. Cap Screw	ISO 4014 M20x110
7	1	0660545	Pin joint \varnothing 50 asm.	
7.1	2	0680054	Washer \varnothing 50	
7.2	1	0660256	Pin	\varnothing 50 x 245
7.3	1	0106030	Hex Nut	ISO 4032 M16
7.4	1	0104111	Socket hd. Cap Screw	ISO 4762 - M16x250
8	1	0660541	Pin joint \varnothing 50 asm.	
8.1	1	0660260	Pin	\varnothing 50 x 118
8.2	2	0680054	Washer \varnothing 50	
8.3	1	0104888	Socket hd. Cap Screw	ISO 4762 - M16x130
8.4	1	0106030	Hex Nut	ISO 4032 M16
9	2	0660542	Pin joint \varnothing 50 asm.	
9.1	2	0680054	Washer \varnothing 50	
9.2	1	0106030	Hex Nut	ISO 4032 M16
9.3	1	0660262	Pin	\varnothing 50 x 84
9.4	1	0104500	Socket hd. Cap Screw	ISO 4762 - M16x90
10	1	0734048	Hydraulic group MG 12	
11	1	0734053	Labels MG 12	

Hydraulic cylinder ø80/56

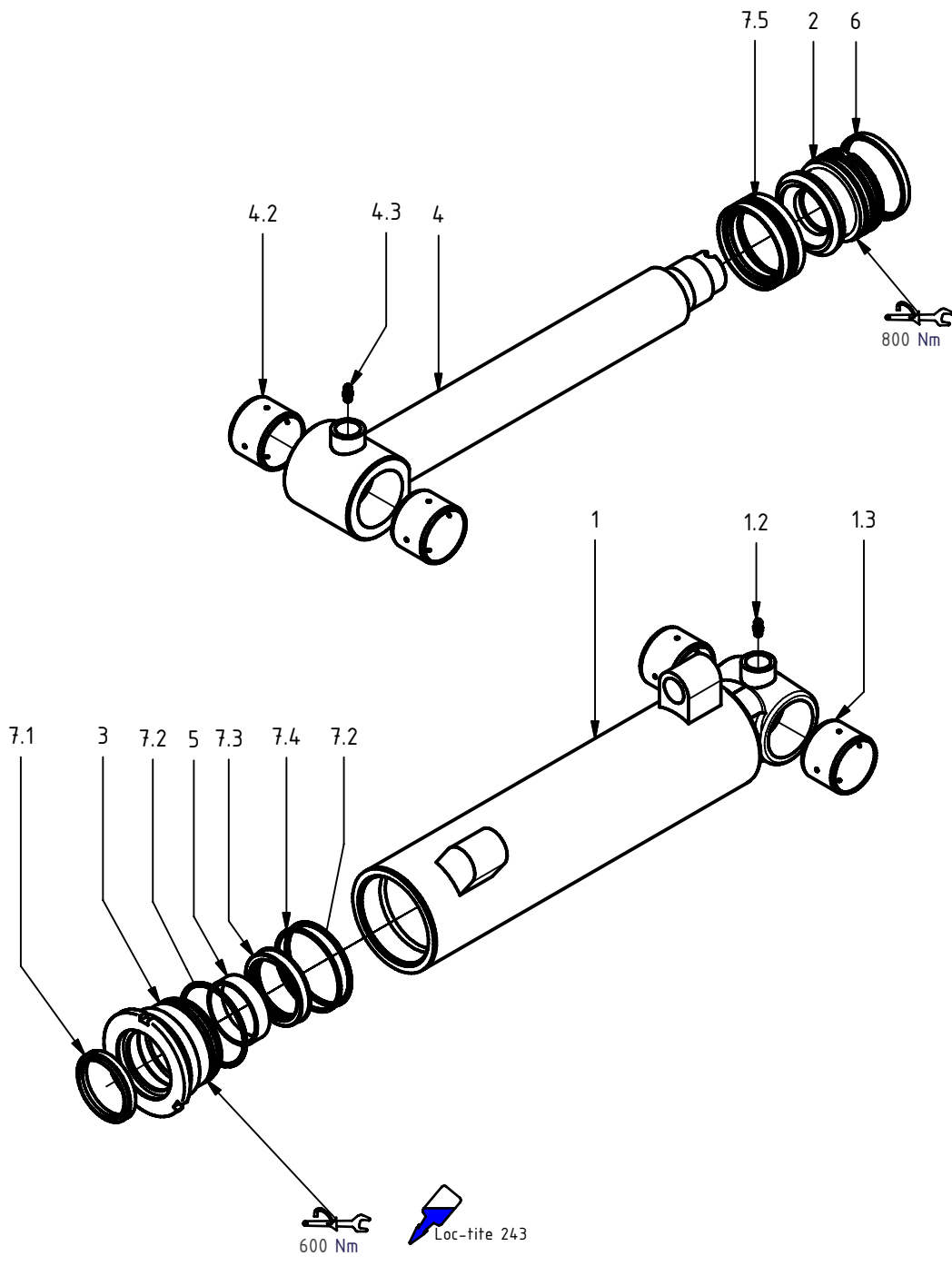

Item	Qty.	Part Number	Description	Notes
1	1	0150501	Barrel asm.	incl. item #1.2-1.3
1.2	1	0114004	Grease Fitting	M6x1
1.3	2	0660223	Plain bearing	ø50/55x40
2	1	0150502	Piston	80/56
3	1	0150503	Gland	80/56
4	1	0150504	Rod asm.	incl. item #4.2-4.3
4.2	2	0660223	Plain bearing	ø50/55x40
4.3	1	0114004	Grease Fitting	M6x1
5	1	0150525	Guide Ring	61/56 x 15-PF
6	1	0150527	Piston Ring	
7	1	0121076	Seal kit 80/56	
7.1	1	-	Dust Seal	PA 56/66 x 7 x 10
7.2	2	-	O-ring	74,5 x 3,0
7.3	1	-	Rod Seal	SI/L 56/71 x 12,5
7.4	1	-	Backup Ring	75/80 x 1,3
7.5	1	-	Piston Seal	M/R-PF 80/65 x 20

Grapple arm, male

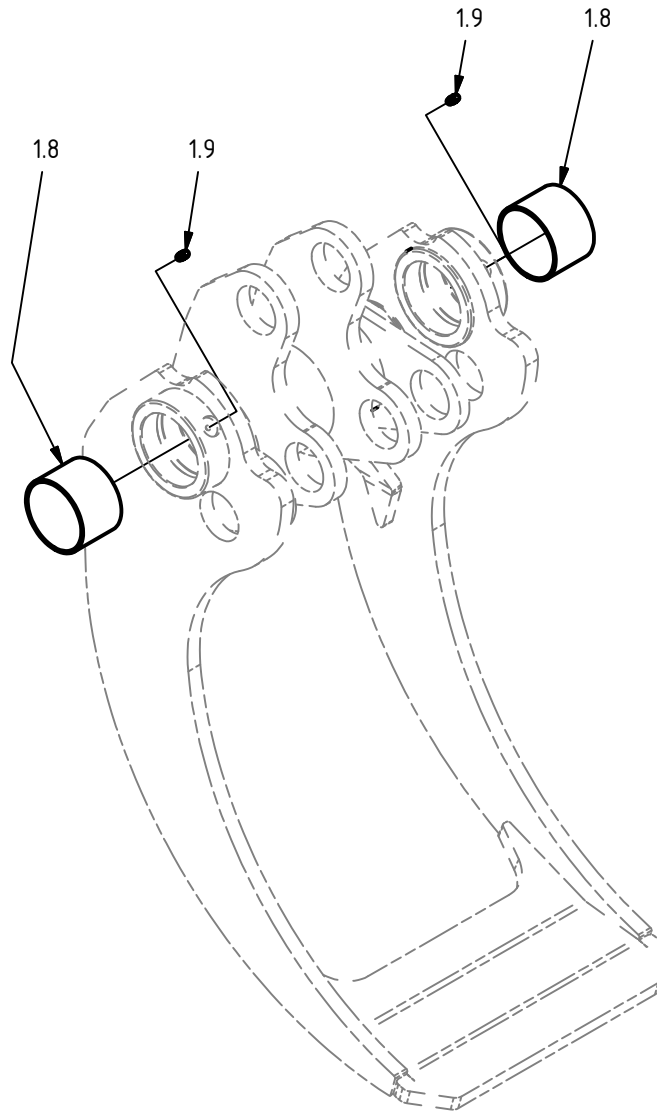

Item	Qty.	Part Number	Description	Notes
1.8	2	0660217	Plain Bearing	70/75x50
1.9	2	0114004	Grease Fitting	M6x1

Grapple arm, female

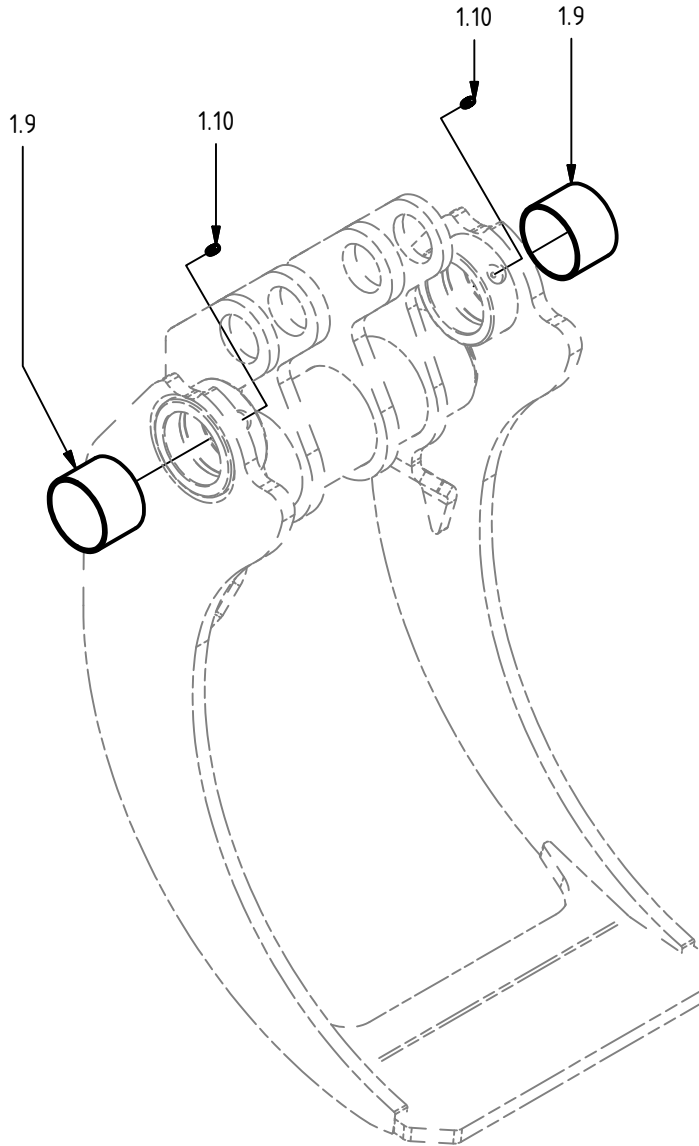

Item	Qty.	Part Number	Description	Notes
1.9	2	0660217	Plain Bearing	70/75x50
1.10	2	0114004	Grease Fitting	M6x1

Push rod asm.

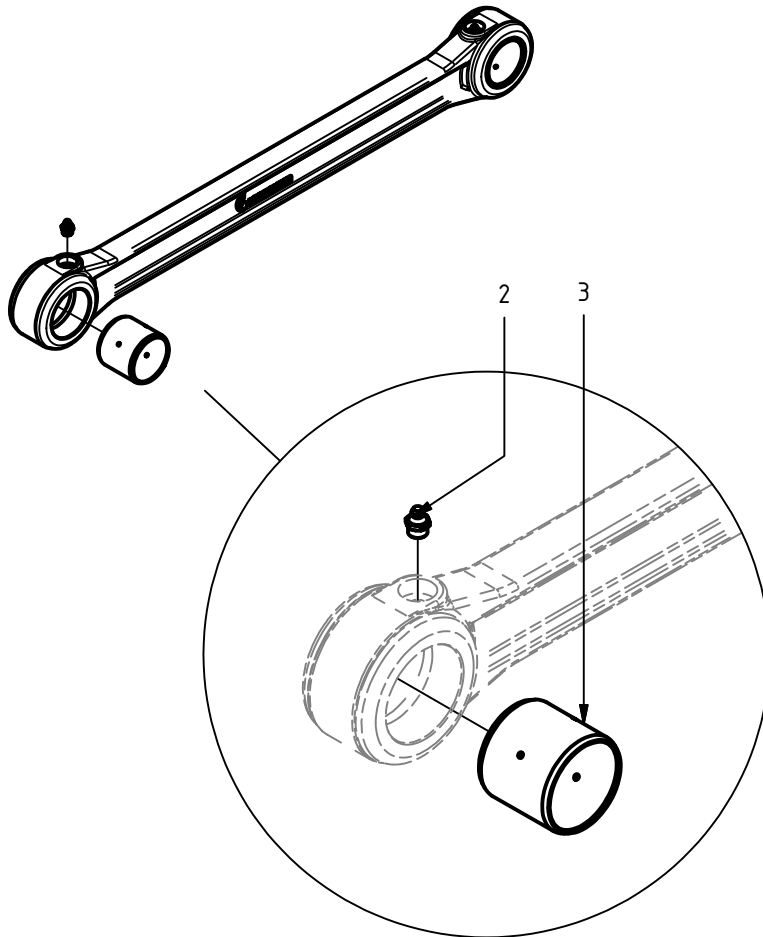

Item	Qty.	Part Number	Description	Notes
2	2	0114023	Grease Fitting	M10 x 1
3	2	0680073	Plain bearing	Ø50/55x50

Load-check asm. MG 12

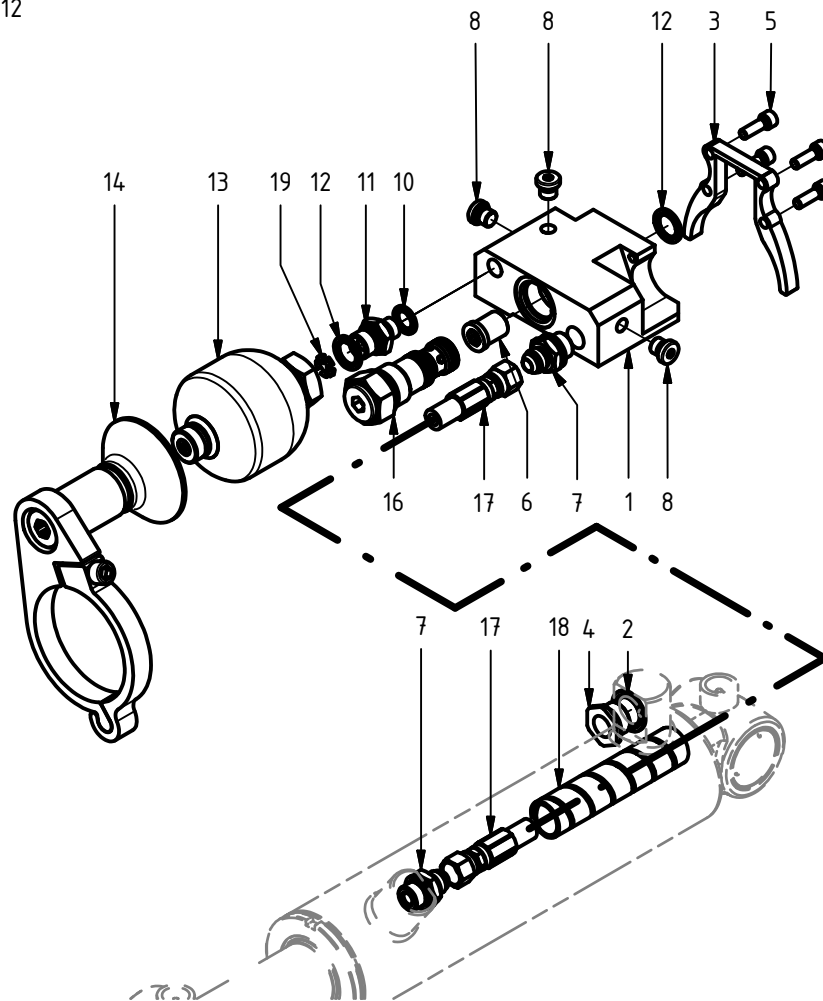

Item	Qty.	Part Number	Description	Notes
1	1	0734009	Manifold	
2	1	0106584	Bonded Seal	D9DT-12
3	1	0734052	Support plate	
4	1	0734012	Adapter	G3/4 - G1/2
5	4	0104442	Socket hd. Cap Screw	ISO 4762 - M8x25
6	1	0130297	Collar screw	BSCH 1/2"
7	2	0130333	Adapter str.	SJG 1208
8	3	0130178	Plug	VST11/4EDA3C
10	1	0106581	Bonded Seal	D9DT-6
11	1	0130439	Restrictor adapter \varnothing 1,5	133-06-08-1,5
12	2	0106577	Bonded Seal	D9DT-8
13	1	0136374	Accumulator 0,32 L	0,32 L - 9,0 MPa
14	1	0734049	Acc. bracket asm. MG 12	
16	1	0136231	Check valve, pilot operated	RP16A-01-C-N-15-4
16.2	1	0121123	Seal kit	FS163-N
17	1	0734077	Hose asm.	3/8", OAL=120 mm
18	1	0734080	Hose cover	L = 145 mm
19	1	0715357	Washer	

Labels MG 12

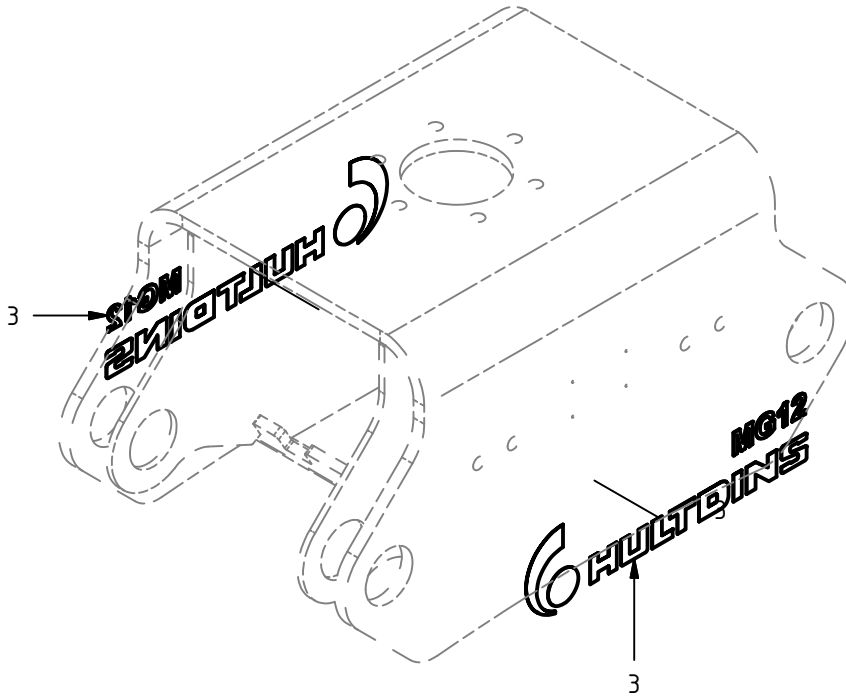

Item	Qty.	Part Number	Description	Notes
3	2	0146126	Label MG12	

Bracket S60 asm.

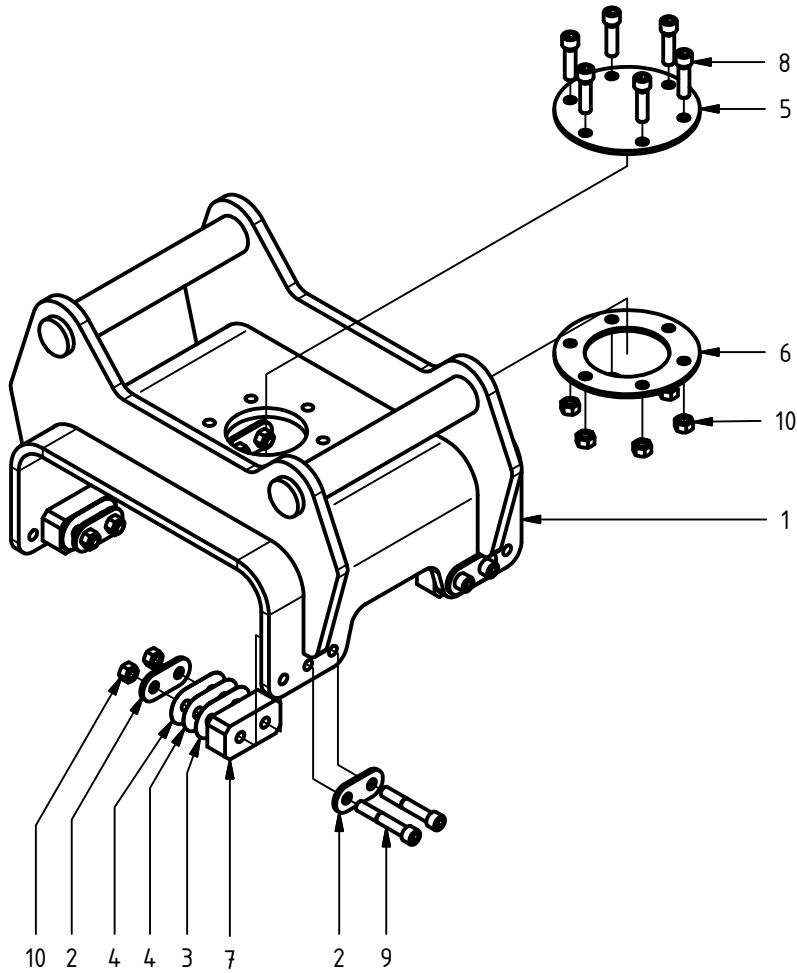

Item	Qty.	Part Number	Description	Notes
1	1	0734306	Bracket S60 asm.	item # 1-10
2	8	0734055	Washer	
3	4	0734056	Shim 1,0	
4	8	0734057	Shim 0,5	
5	1	0734024	Plate	
6	1	0734025	Plate	
7	4	0734058	Spacer	
8	6	0104121	Socket hd. cap screw	ISO 4762 - M16x60
9	8	0104093	Socket hd. Cap Screw	ISO 4762 - M16x100
10	14	0106030	Hex Nut	ISO 4032 M16

HULTDINS MultiGrip



Hultdin System AB
Skolgatan 12, SE-930 70 MALÅ, Sweden
tel. +46 953 418 00, fax +46 953 418 01
E-mail: sales@hultdins.se

English

Hultdins Inc.
22 Morton Avenue East
Brantford, Ontario, Canada N3R 7J7
tel (519) 754-0044, fax (519) 754-1569
E-mail: info@hultdins.com